



Luxury^{art}
DESIGN WITH EMOTIONS

2019

katalog





sztukaterii

Spis treści:

listwa wokółokienna	str 3
listwa podparapetowa	str 7
szprosy podokienne	str 10
wsporniki	str 12
zworniki	str 14
gzymy nadokienne	str 16
gzymy pośrednie	str 18
gzymy wieńczące	str 21
podpory balkonowe	str 24
bazy pilastrów	str 26
głowice pilastrów	str 28
pilastry	str 30
architrawy	str 32
otuliny kolumn	str 34
pedestały	str 36
głowice kolumn	str 38
bazy kolumn	str 40
bonie	str 42
koła i łuki	str 44

Oferta firmy Luxury Art to profesjonalna sztukateria przystosowana do stosowania przy elewacjach oraz we wnętrzach domów i mieszkań. Jako firma nieustannie podnosimy jakość naszych wyrobów, samodzielnie narzucając sobie coraz większe wymagania. Produkujemy elementy sztukaterii elewacyjnej, wśród której znajdują się: gzymsy- doskonale ozdabiające okna oraz tarasy budynków, bonie - wspaniale wyglądające jako ozdobniki kątów ścian oraz elewacji, głowice - bardzo wyszukany produkt zdobiący każdą elewację dużych i średnich domów oraz kamienic, kolumny - nowatorskie oraz bardzo gustowne, pasujące zarówno przed wejście główne, jak i ozdabiające taras lub balkon. W naszej ofercie znaleźć można również: listwy przysufitowe - idealne jako wykończenie do każdego pomieszczenia, listwy ścienne- przystosowane do ozdoby ścian wewnątrz mieszkań oraz domów, listwy oświetleniowe- gustowne listwy zapewniające wysoką jakość oświetlenia pomieszczenia oraz unikalny klimat, panele 3D - doskonale imitują obraz trójwymiarowy na ścianach pomieszczeń, Idealne do zastosowania nad kominkami lub ścianami ozdobnymi.

LEGENDA:

-  bardzo łatwy montaż
-  odporne na warunki atmosferyczne
-  można malować farbami elewacyjnymi silikonami-akryle
-  twarde a zarazem elastyczne
-  samogasnące



Listwa
wokółokienna

LO 1

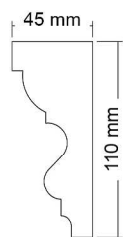

LO 4

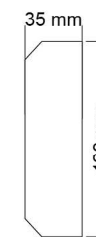

LO 1A

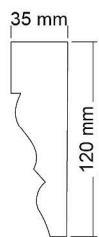

LO 5

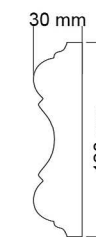

LO 2

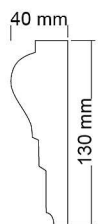

LO 5A



LO 3

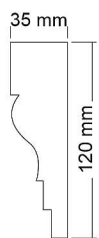

LO 5B

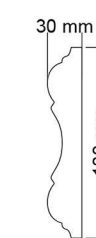

LO 6

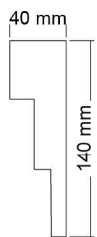
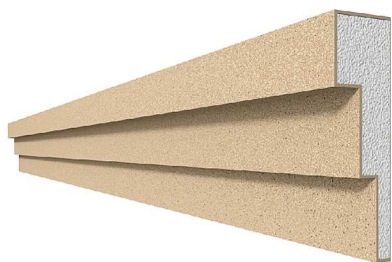

LO 10

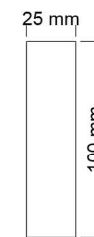

LO 7

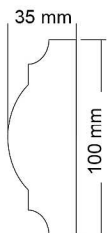

LO 11



LO 8

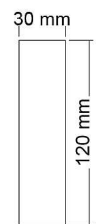

LO 12



LO 9



LO 13

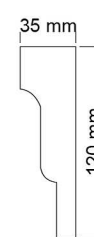
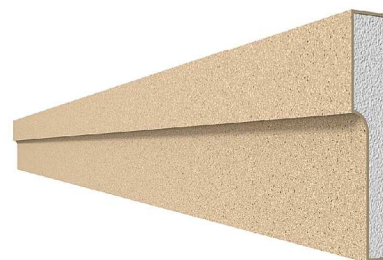

LO 14

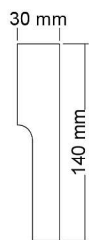
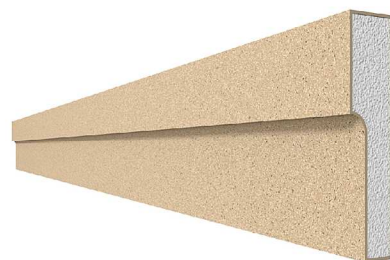

LO 18

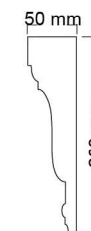

LO 15

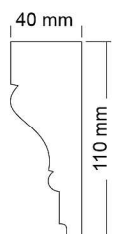

LO 19

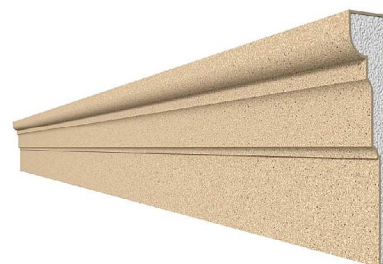

LO 16

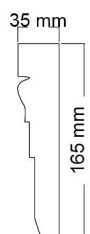

LO 21



LO 17

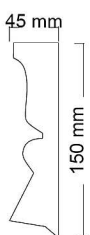
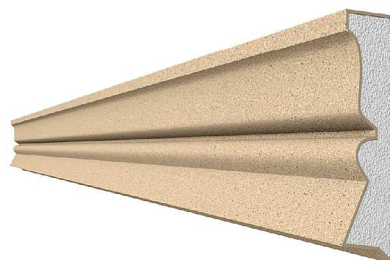



Listwa
podparapetowa

LP 1

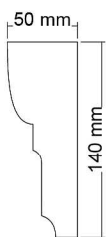

LP 5

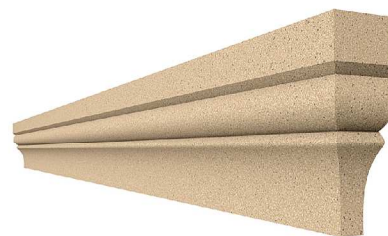

LP 2

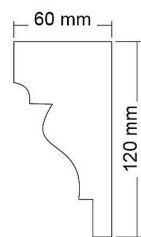

LP 6

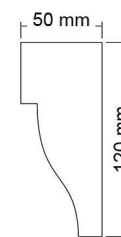
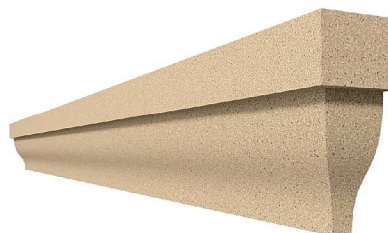

LP 3

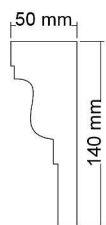

LP 7



LP 4

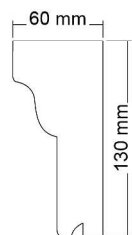

LP 8

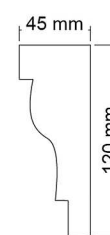

LP 9

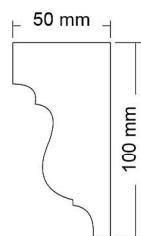
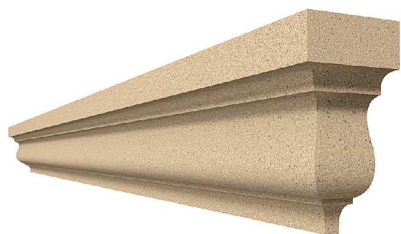

LP 13



LP 10

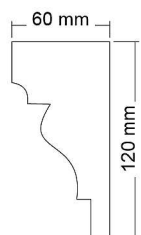

LP 11

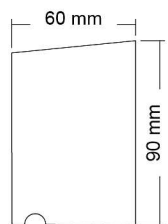

LP 12

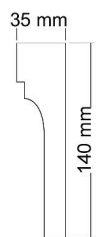



Szprosy
podookienne

SZP 1

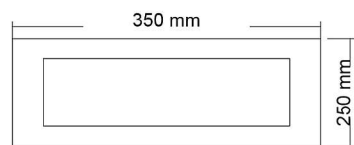
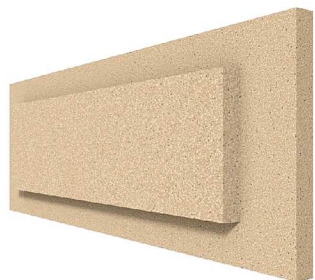

SZP 2

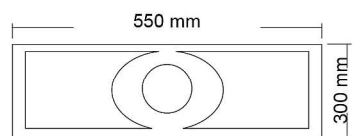
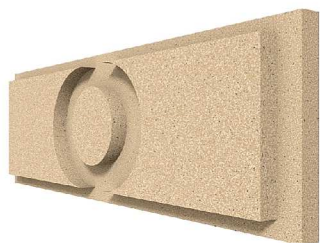

SZP 3

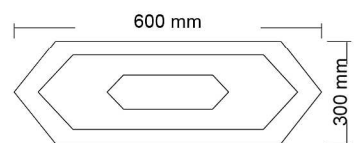

SZP 4

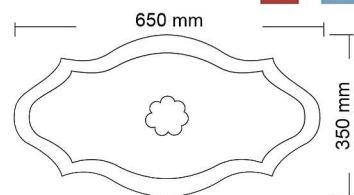

SZP 5

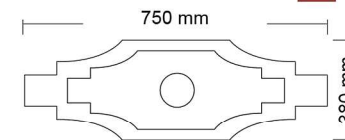



Wsporniki

WX 1

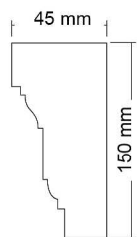

WX 8

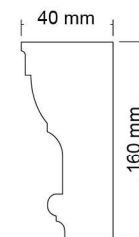

WX 2

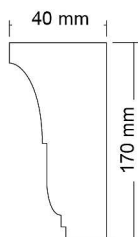

WX 3

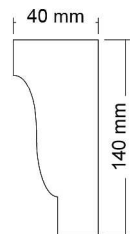

WX 5

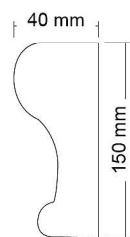



Zworniki

LP 1

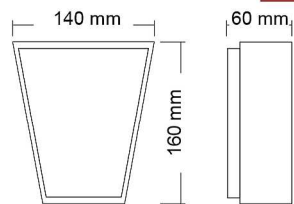

LP 5

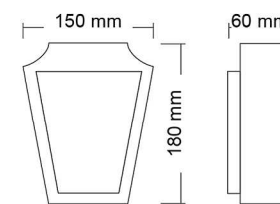

LP 2

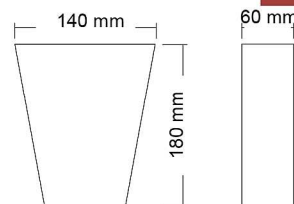

LP 6

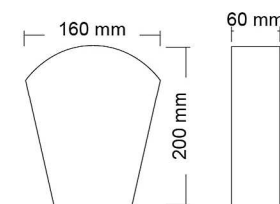

LP 3

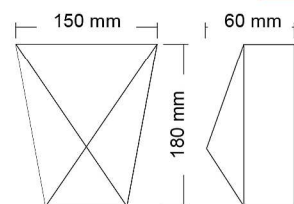

LP 7

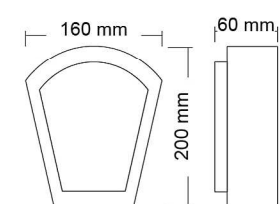

LP 4

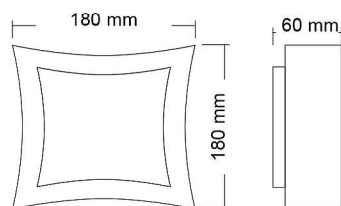

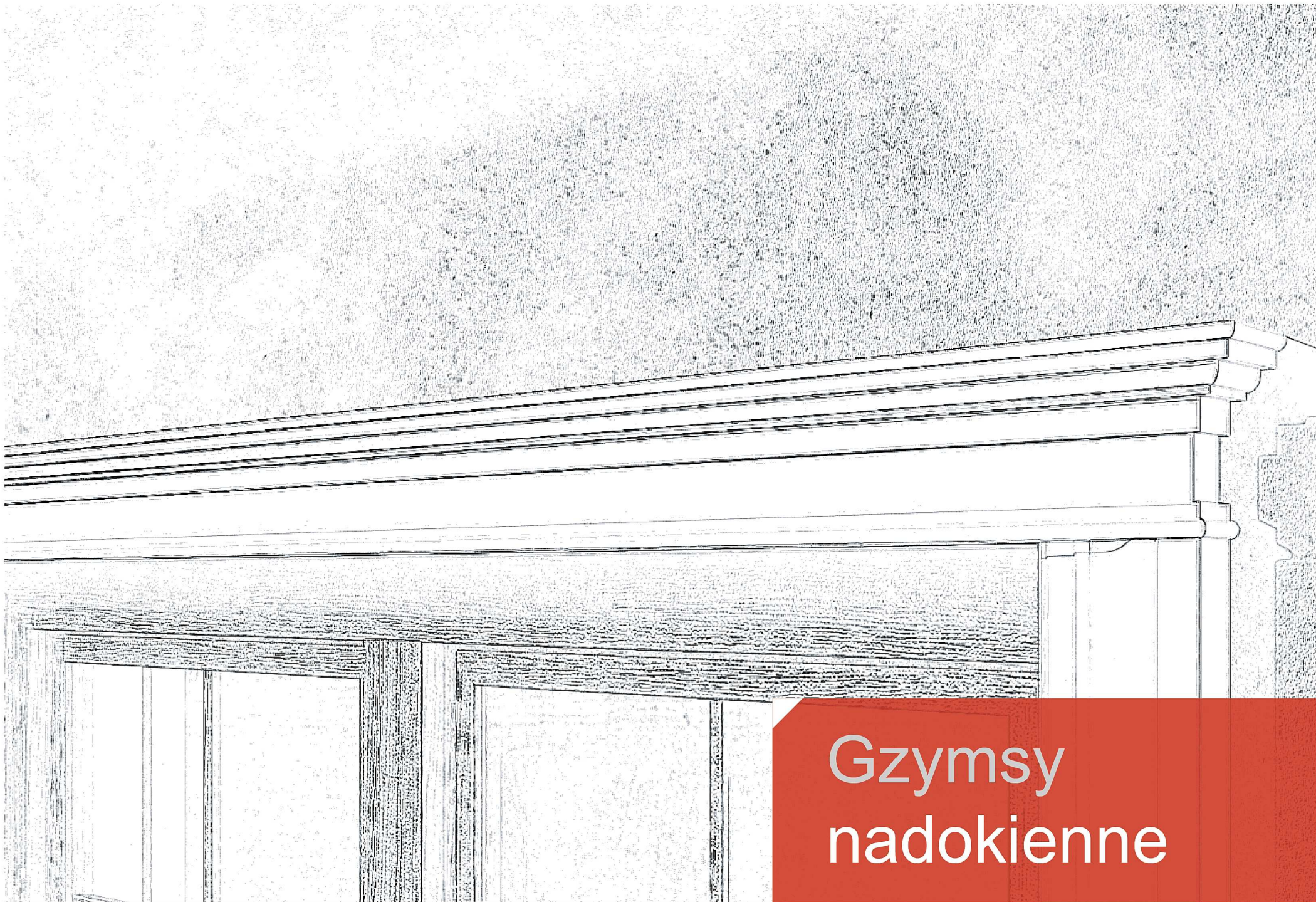

Gzymsy
nadokienne

GN 1

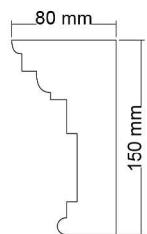

GN 5

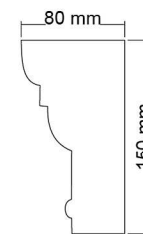

GN 2

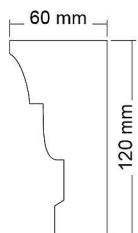
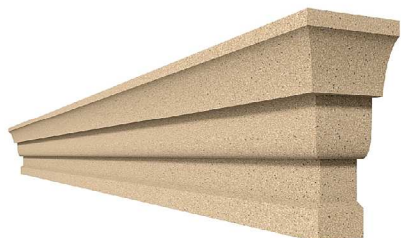

GN 6

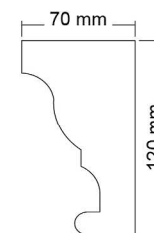

GN 3

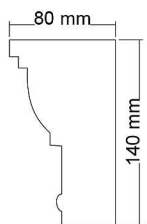

GN 7

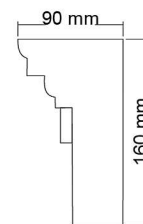

GN 4

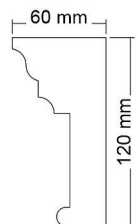

GN 8

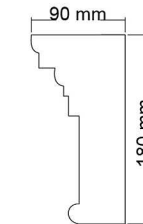

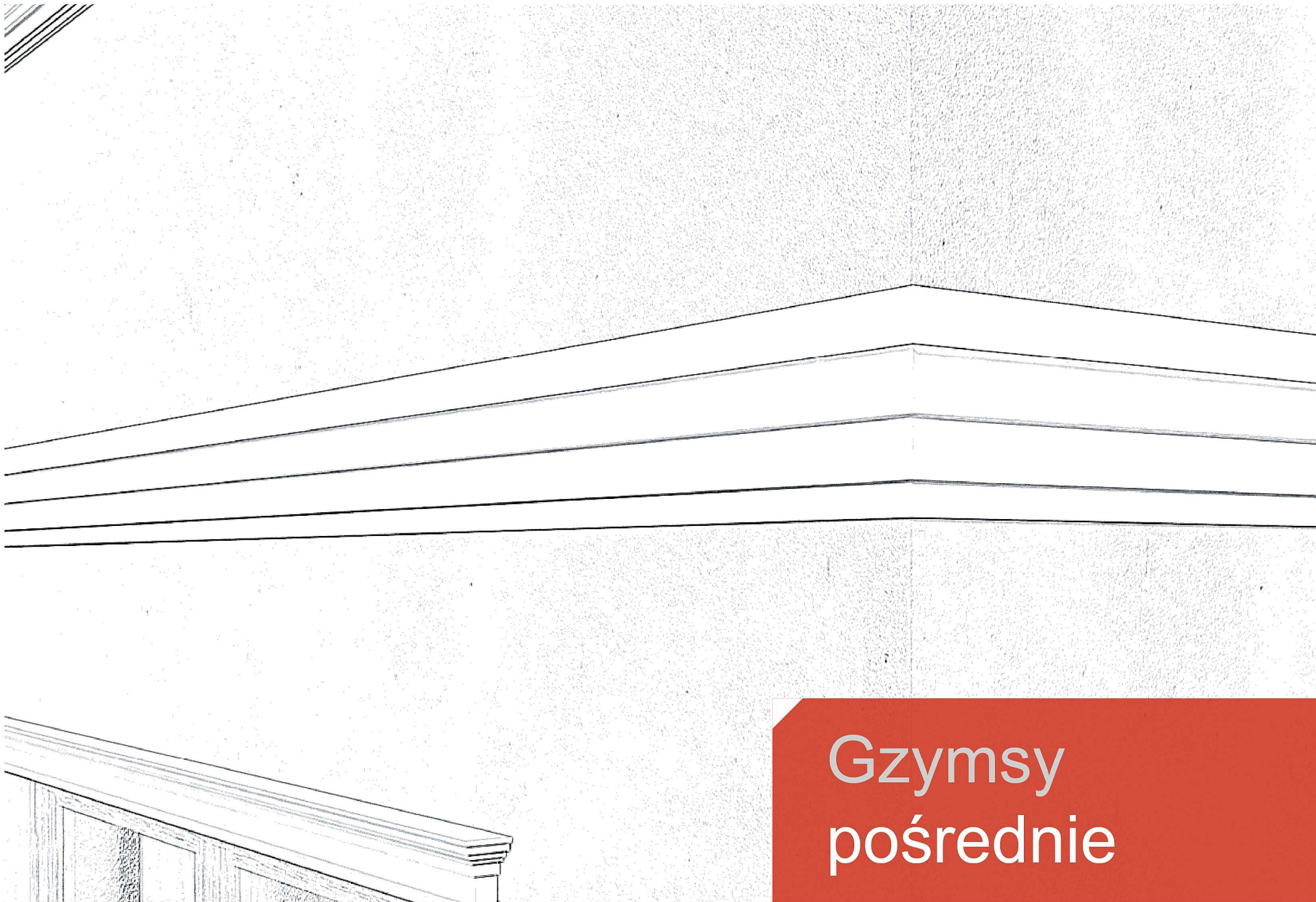

Gzysy
pośrednie

GP 1

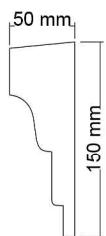
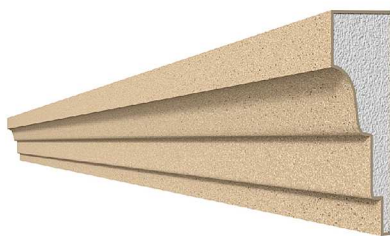

GP 5

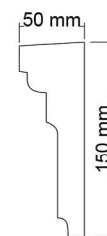

GP 2

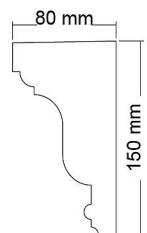

GP 6

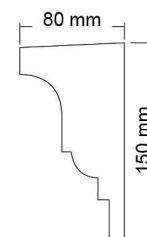

GP 3

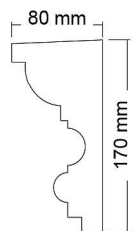

GP 7

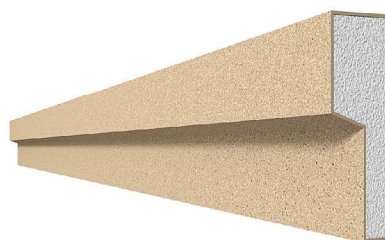

GP 4GP

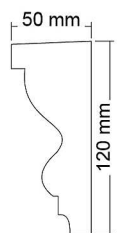

GP 8

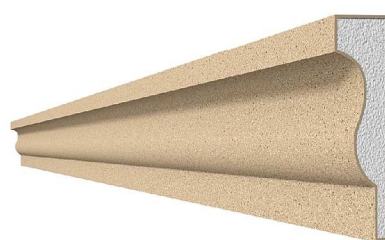

GP 9

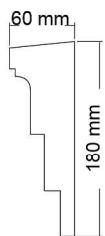



Gzymсы wieńczęce

GL 1

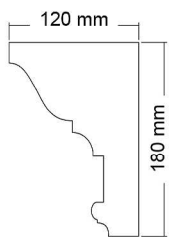
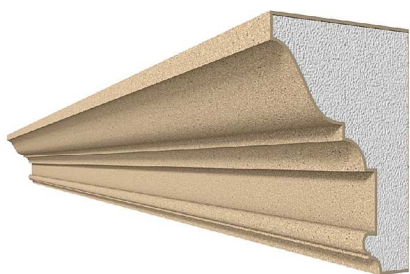

GL 5

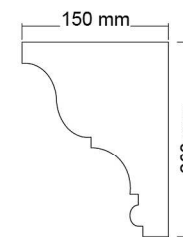
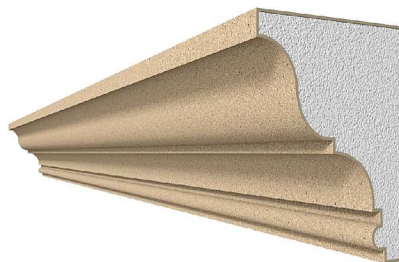

GL 2

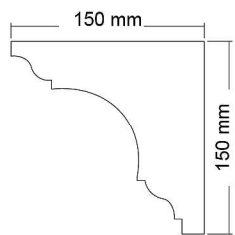

GL 6

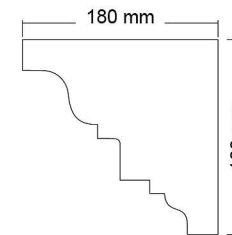
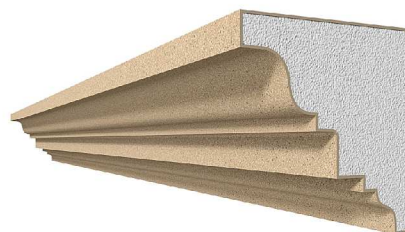

GL 3

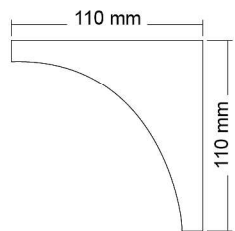

GL 7

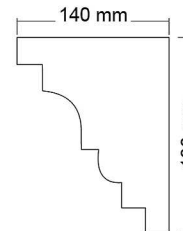

GL 4

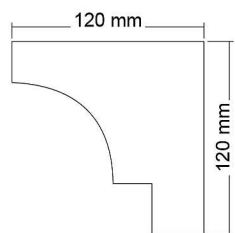
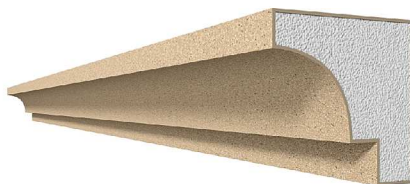

GL 8

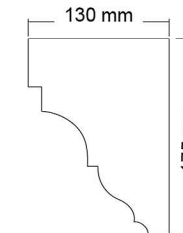
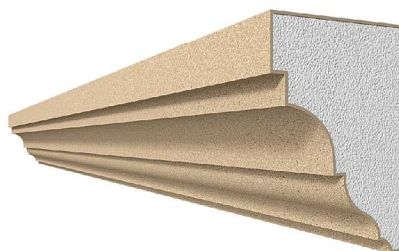

GL 9

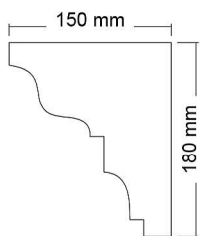

GL 13

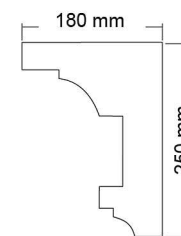
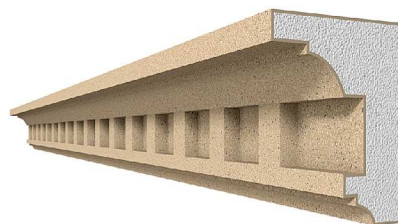

GL 10

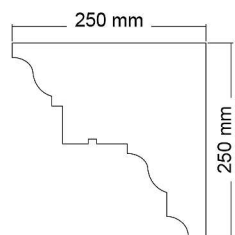
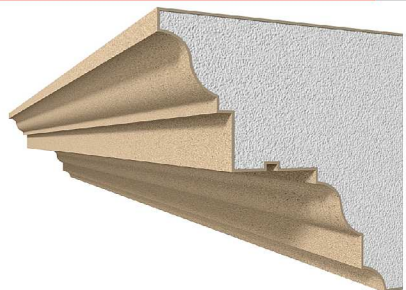

GL 14

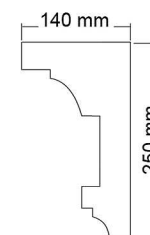
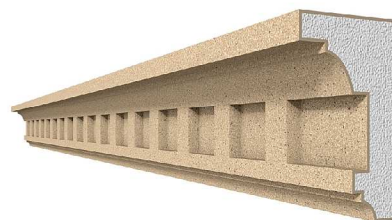

GL 11

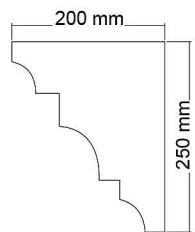
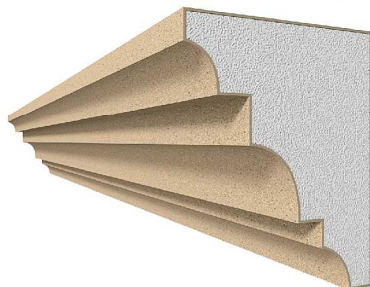

GL 12

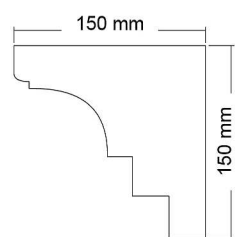
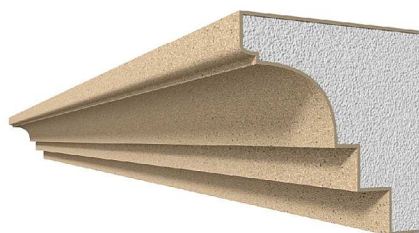



Podpory
balkonowe

PX 1

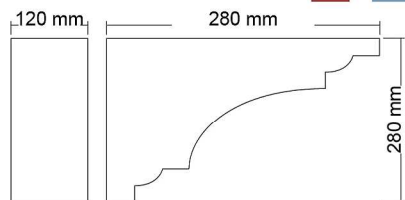
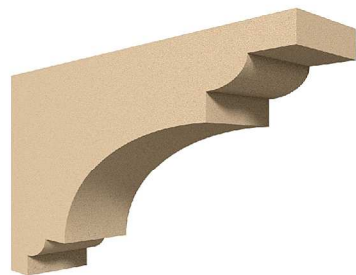

PX 5

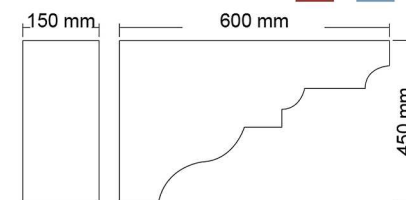
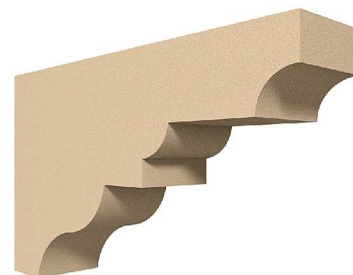

PX 2

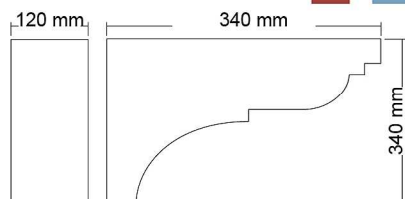
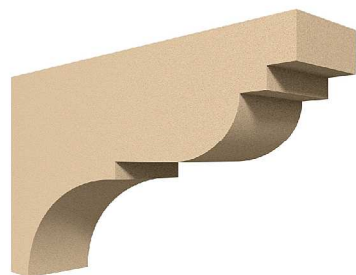

PX 6

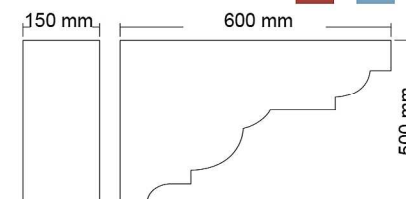
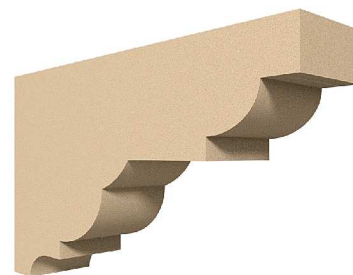

PX 3

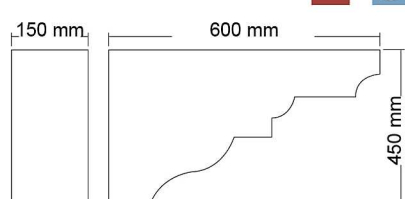
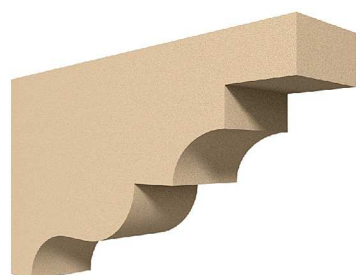

PX 7

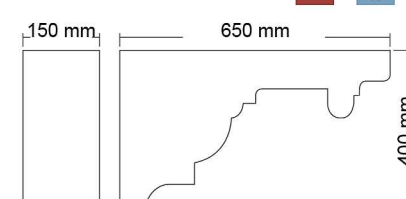
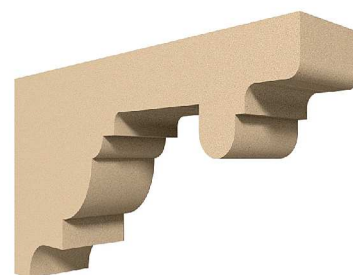

PX 4

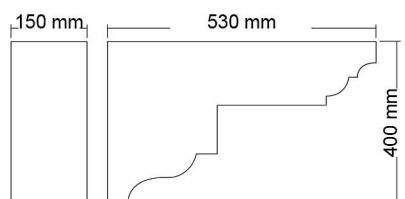
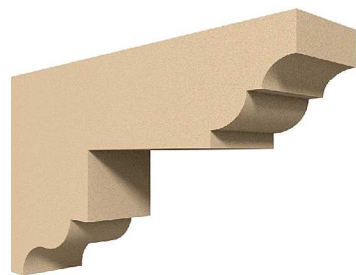

PX 8

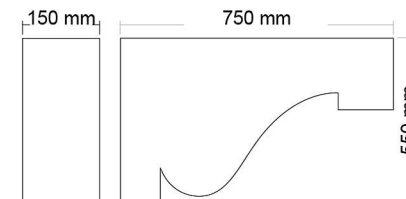
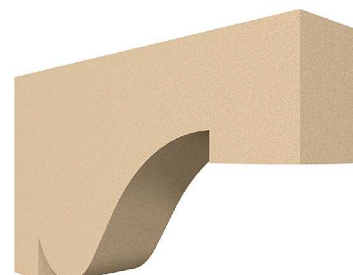



Bazy
pilastrów

BZ 1

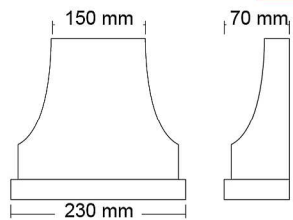

BZ 5

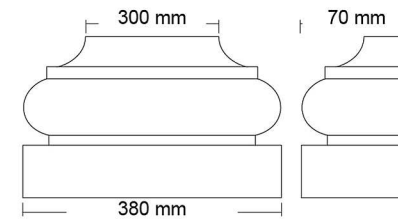

BZ 2

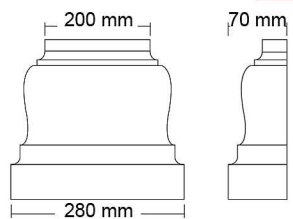

BZ 3

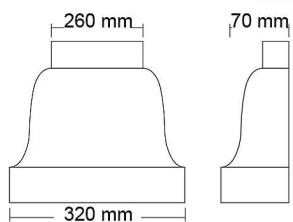

BZ 4

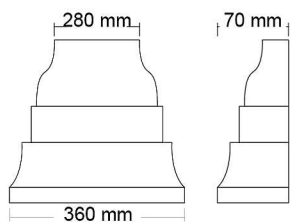



Głowice
pilastrów

GZ 1

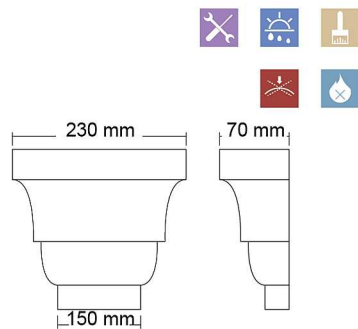

GZ 2

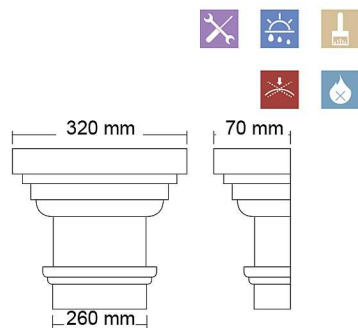

GZ 3

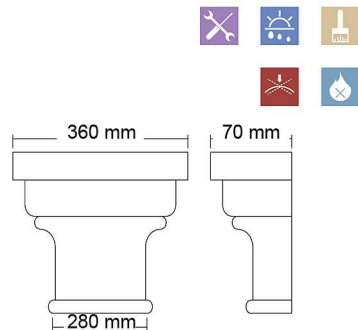

GZ 4

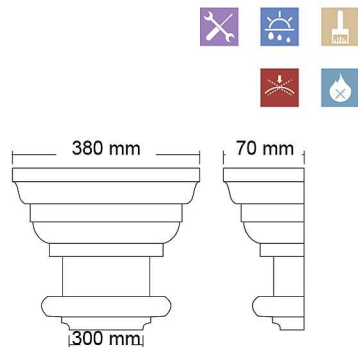

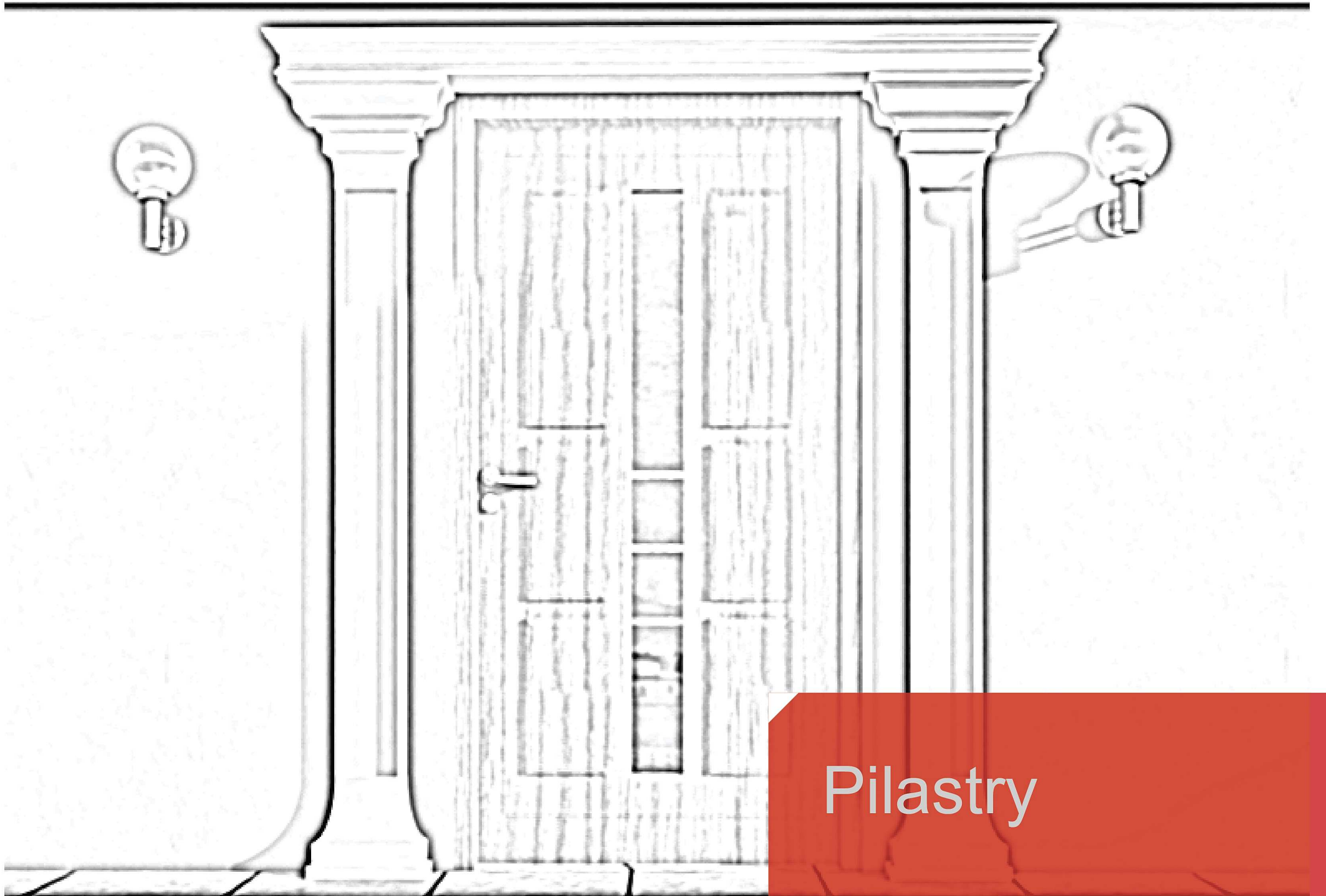

Pilastri

PL 1

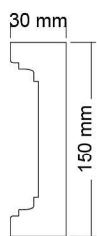

PL 5



PL 2

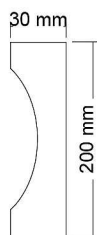

PL 3

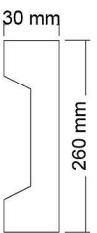
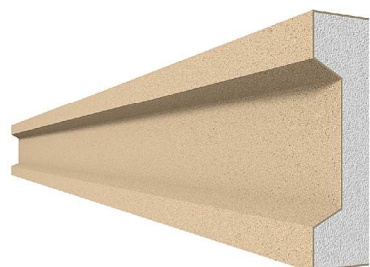

PL 4

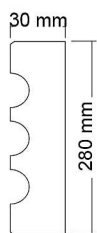
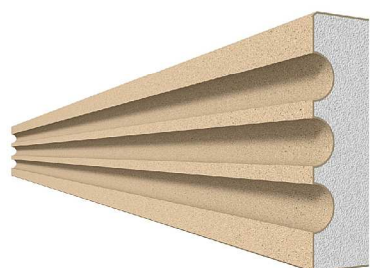

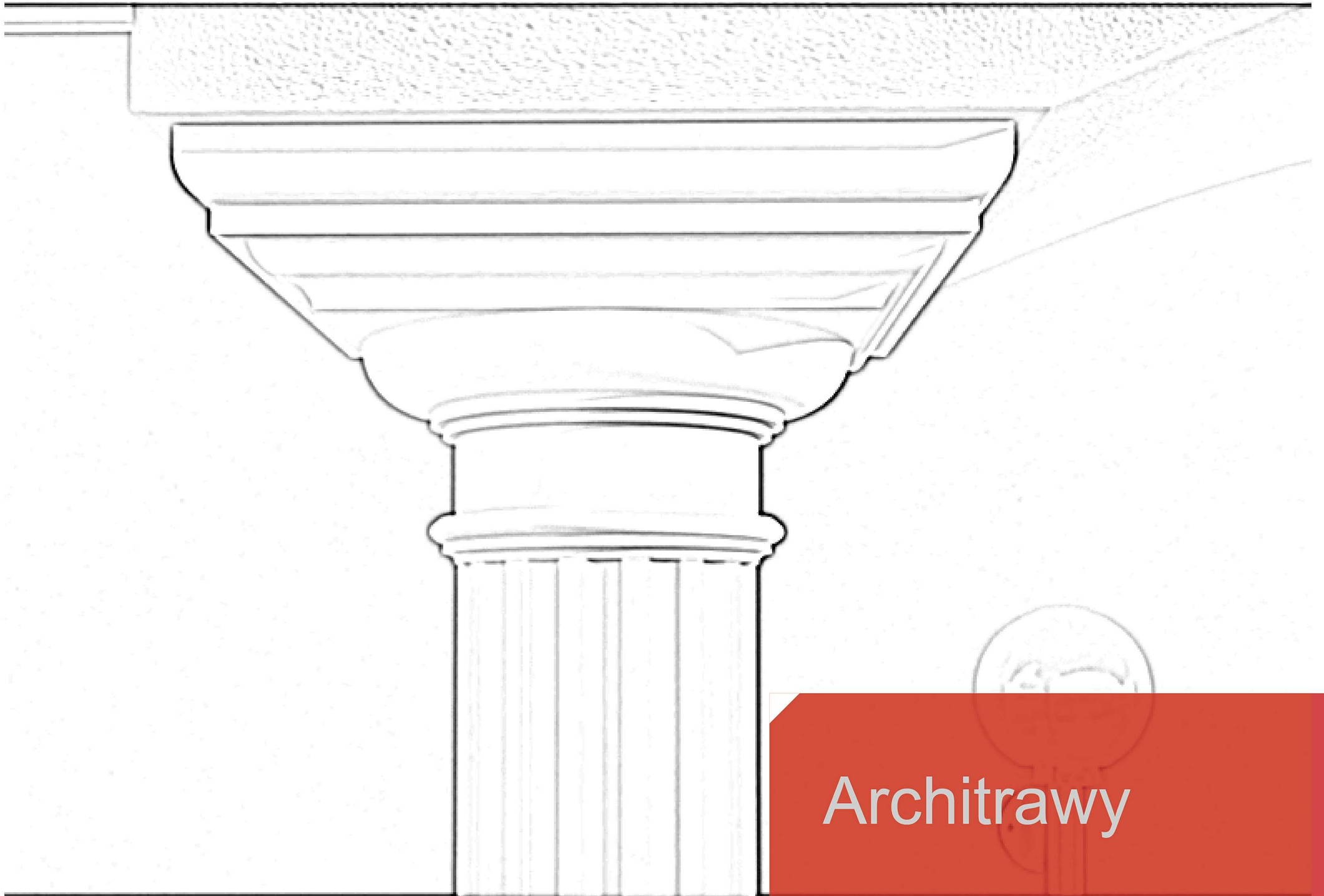

Architrawy

AR 1

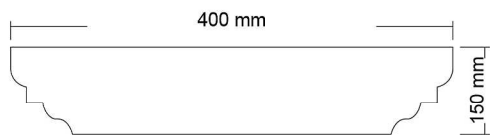

AR 5

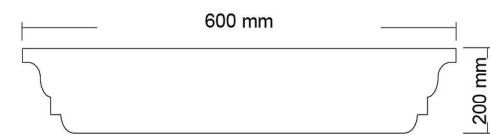

AR 2

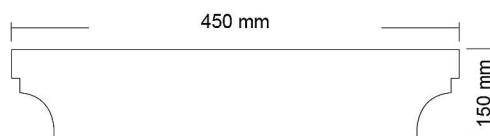

AR 6

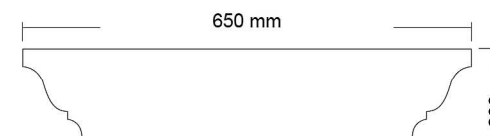

AR 3

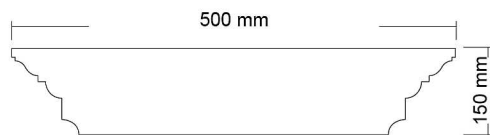

AR 4

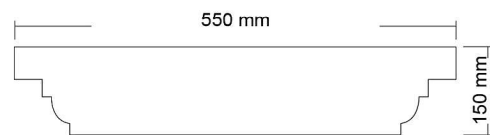

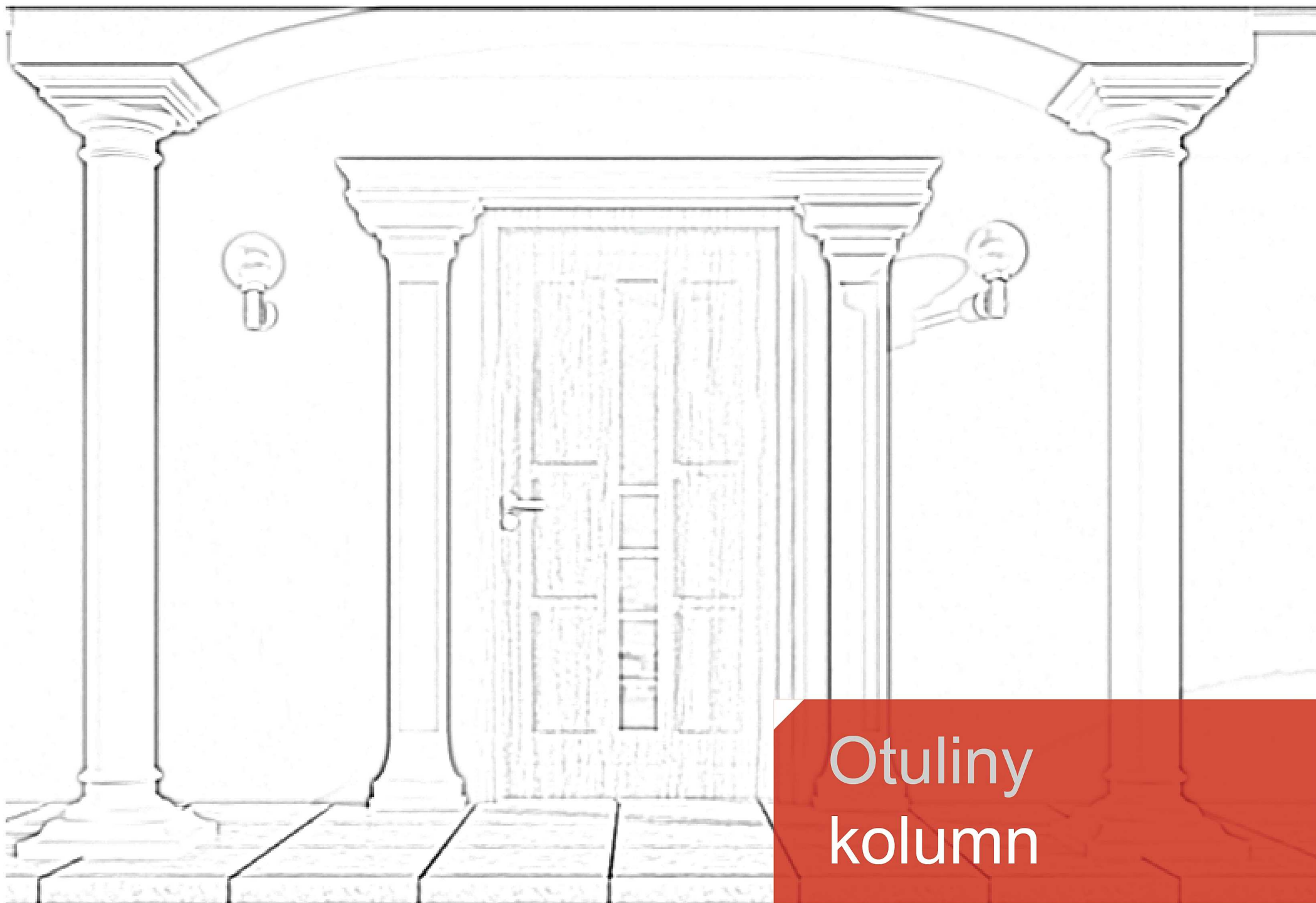

Otuliny
kolumn

OS 1

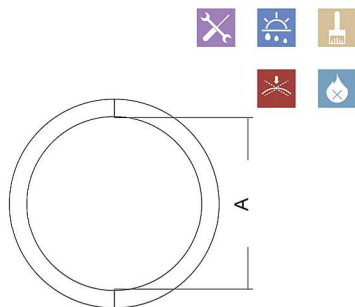

OS 2

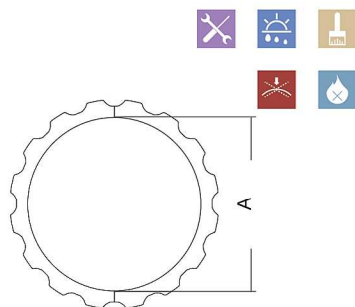

OS 3

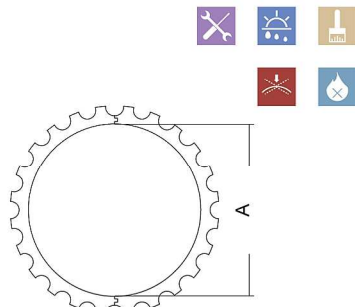

OS 4

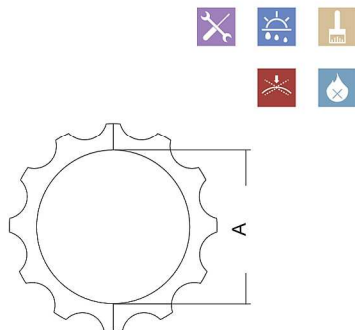

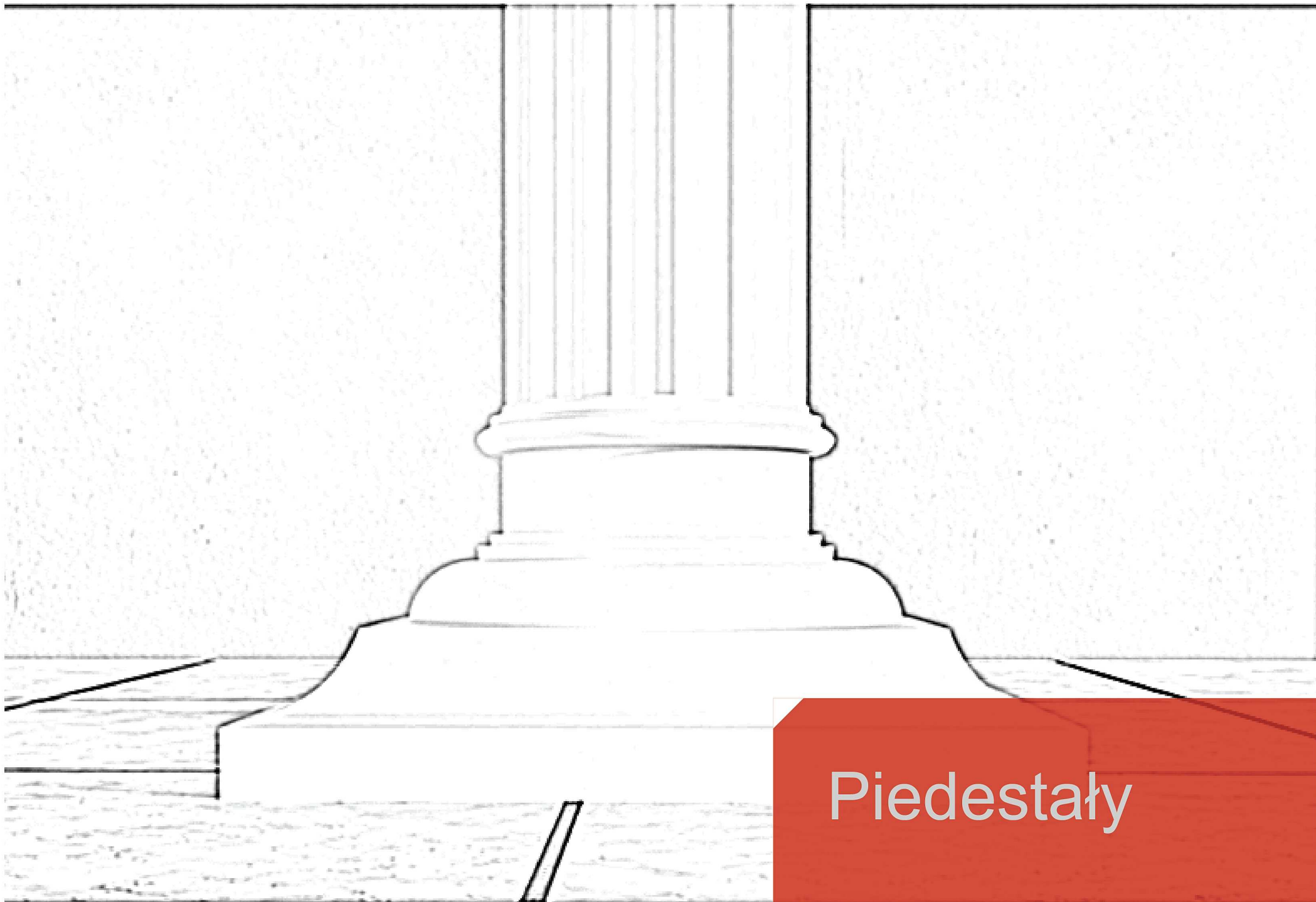

Piedestały

PD 1

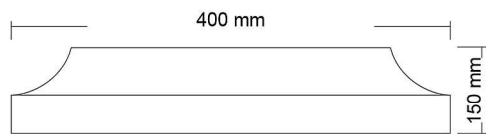

PD 5

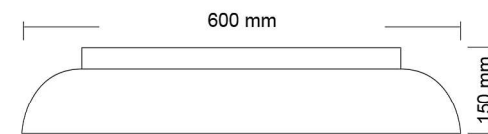
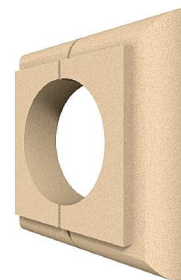

PD 2

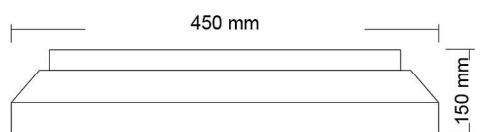
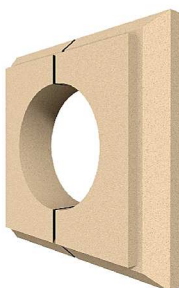

PD 6

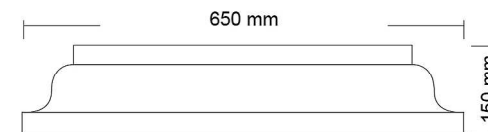
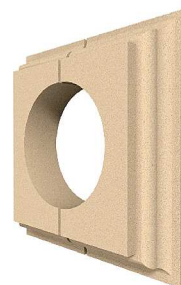

PD 3



PD 4

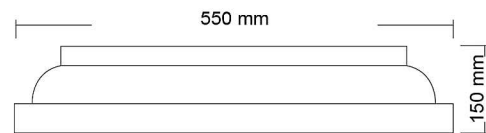
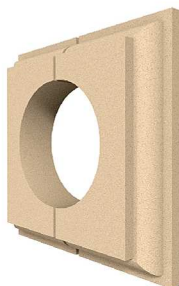



Głowice
kolumn

G1

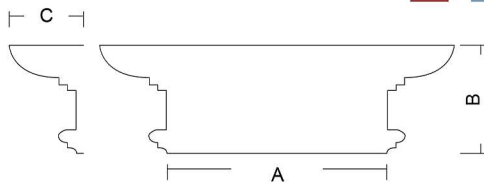

G5

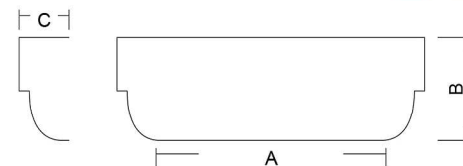

G2

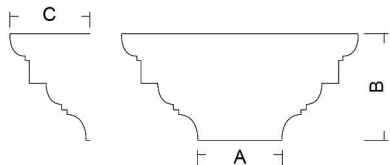

G6

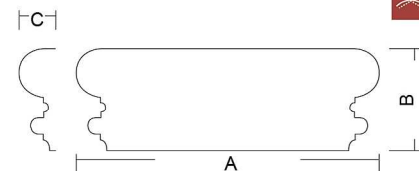

G3

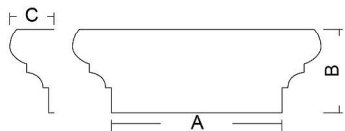

G4

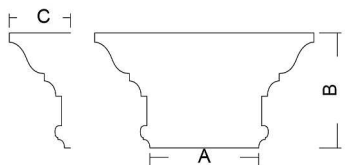



Bazy
kolumn

BZ 1

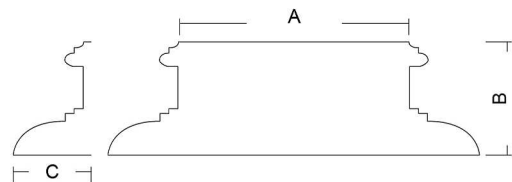

BZ 5

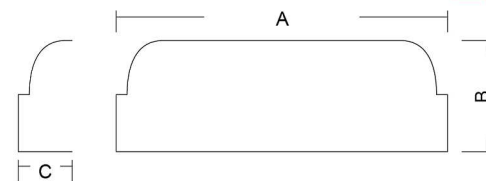

BZ 2

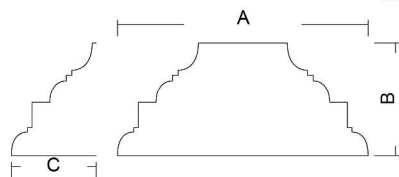

BZ 6

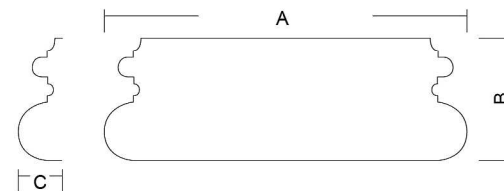

BZ 3

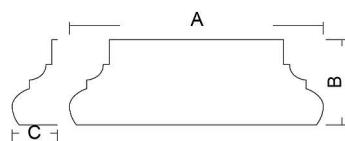

BZ 4

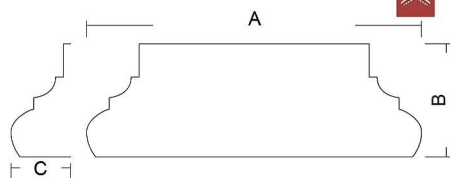

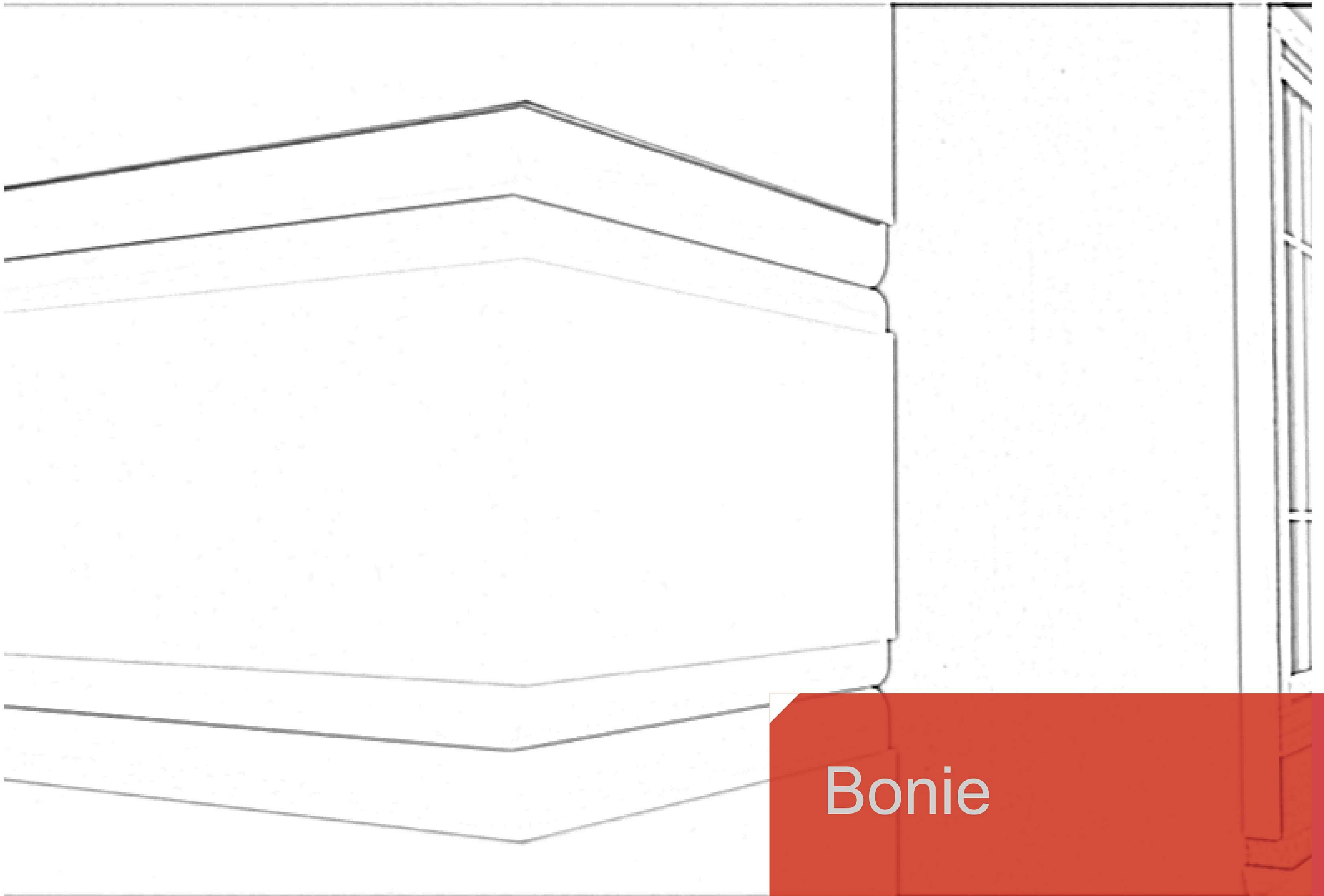

Bonie

B 1

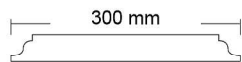

B 5

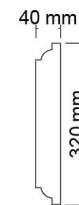
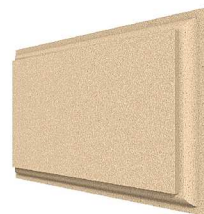

B 2

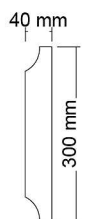

B 6

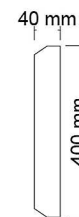
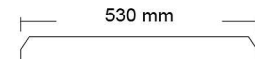

B 3

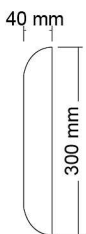
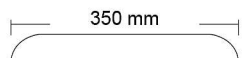

B 4

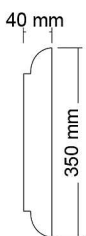

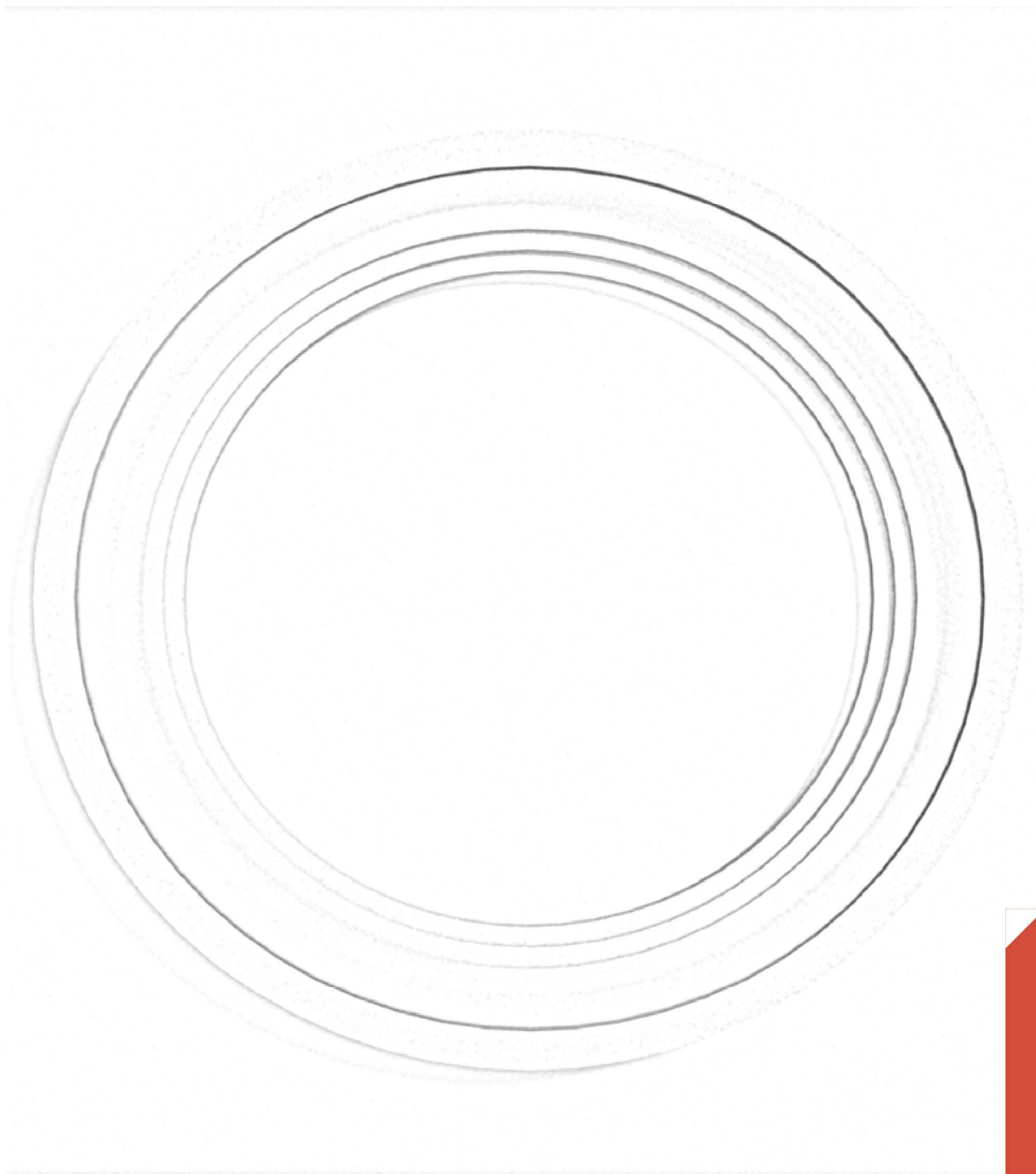

Łuki i koła

KO 1

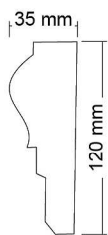
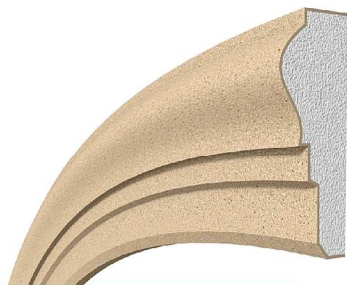

KO 5

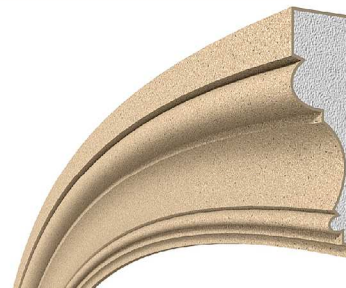

KO 2

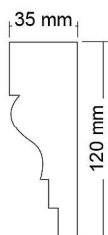
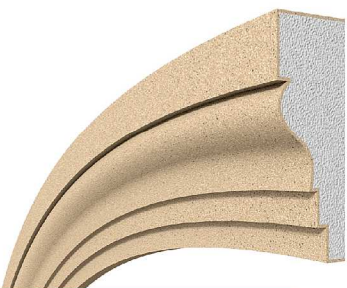

KO 6

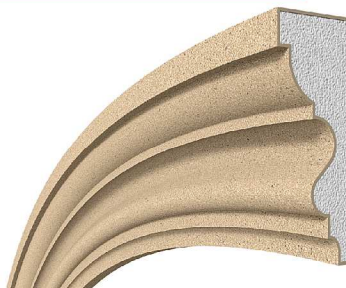

KO 3

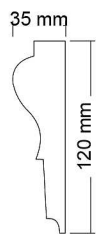

KO 7

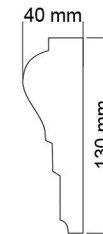

KO 4

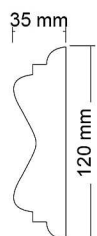

KO 8

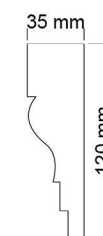

KO 9

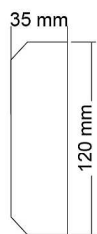
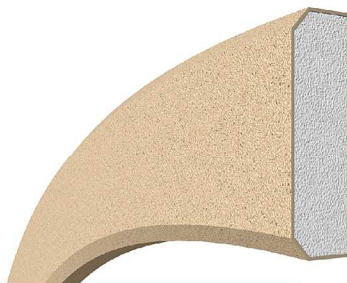

KO 13



KO 10

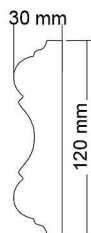

KO 14

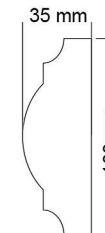

KO 11

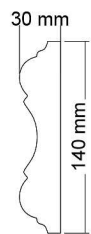

KO 15

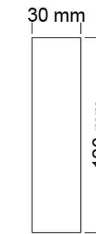
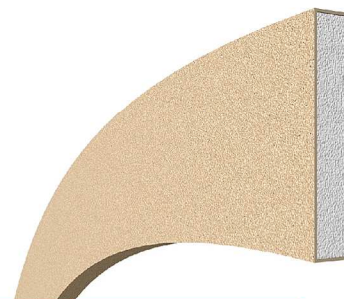

KO 12

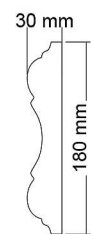

KO 16

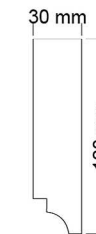

KO 17

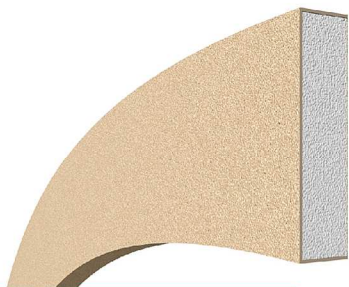

KO 21



KO 18

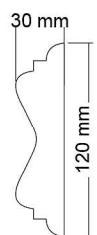

KO 22

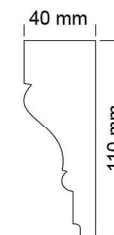

KO 19

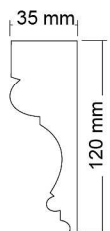
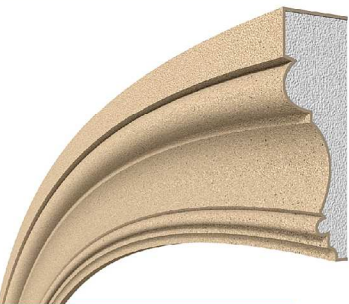

KO 23

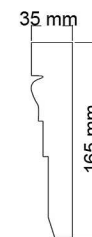

KO 20

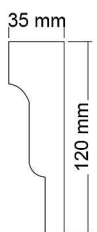
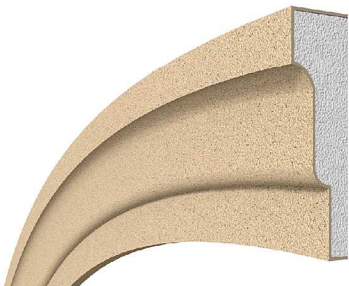

KO 24

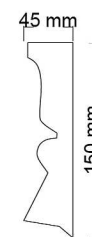
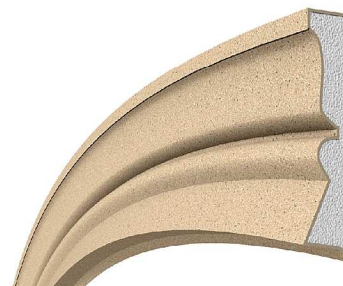

KO 25



KO 26

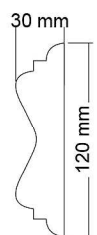

KO 27

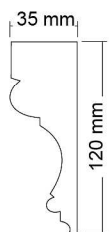
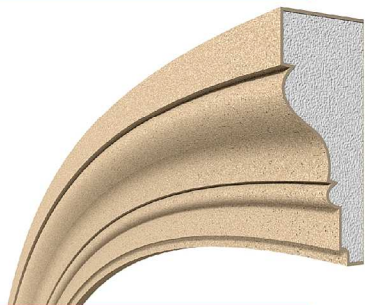

OK 01

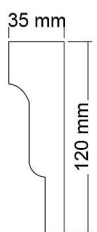

Dane kontaktowe:

tel. 663-036-206, 786-294-288

www.perfectstyr.pl , email : perfectstyr@gmail.com

www.luxury-art.eu , email : design@luxury-art.eu

